

MaxMotion

IEC PERFORMANCE DATA SHEET IEC Efficiency Level IE3

Catalog #: **IJC200L1-2-47**

HP	kW	Voltage	L.R. Amps	Efficiency	Power Factor	Service Factor	Frame	Design
40,00	29,84	460 / 796	345,33	92,4%	0,89	1,15	200L	N

60 Hz								
FLA							Is/In	F.L. RPM
208	230	333	460	575	796	990		
/	/	/	45,80	/	26,50	/	7,54	3550

50 Hz								
FLA						Efficiency	Is/In	F.L. RPM
190	380	400	415	660	725			
/	54,90	52,16	50,30	31,60	28,80	93,3%	7,5	2960

Wgt. Lbs	PH	Duty	Insul. Class	Ambient Temp.	Elevation	Temp. Rise° C
550	3	S1	H	40°C	1000 M	58,3

% Efficiency		% Power Factor		Torque			Protector Type	Winding Resist. Ω
Full Load:	92,4%	Full Load:	0,89	FLT ft.lbs	60Hz	50Hz		
3/4 Load:	92,3%	3/4 Load:	0,87	LRT %	206	206	PTC-150°C	0,13164
1/2 Load:	90,9%	1/2 Load:	0,81	BDT %	235	235		

Rotor Inertia Wk2 Lb-Ft2	Max Load Inertia Wk2 Lb-Ft2	Shaft Material	Frame Material	DE Bracket Type	ODE Bracket Type	Mounting	Enclosure	Protection
-	-	Standard	Cast Iron	Standard	Standard	B3	TEFC	IP55

Ball Bearings		Grease	Mount Type	Orientation	Cold Start (Secs)	Paint
DE	ODE					
6312-C3	6312-C3	Mobil PolyRexEM	Rigid	Horizontal	15	Red

Inverter Duty. Motor meets MG1 parts 31.4.4.2	Constant Torque Range	Variable Torque Range
	10:1	20:1

WIRING CONNECTION DIAGRAM : E

IEC Frames 200L - 355L, Dual Voltage
460 / 796 VAC, 6 posts, 6 leads, Δ / Y Connection

Low Voltage (460 Vac)
6 Leads Δ 6 posts

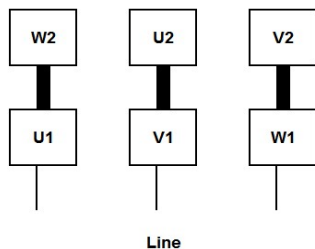

High Voltage (796 Vac)
6 Leads Y 6 posts

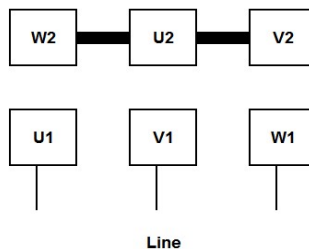



Date: 25 janvier, 2024
 Customer: _____
 Contact: _____
 Submittee: J.C. Lavallée

Catalogue #: IJC200L1-2-47

IEC Efficiency Level IE3											
HP	Kw	VAC	RPM	Enclosure	Frame	Frequency	Design	Poles	LR Is/In	Insulation Class	Temp. Rise °C
40,00	29,84	460 / 796	3550	TEFC	200L	60	N	2	7,54	H	58,3
	0Hz	6Hz	15Hz	30Hz	45Hz	60Hz	75Hz	90Hz	105Hz	120Hz	
Amps	45,80	45,80	45,80	45,80	45,80	45,80	45,80	45,80	45,80	45,80	45,80
RPM	0	355	888	1775	2663	3550	4438	5325	6213	7100	
Torq ft.lb	47,34	59,18	59,18	59,18	59,18	59,18	47,34	39,45	33,82	29,59	
Peak Tq ft.lb	64,36	128,71	128,71	128,71	128,71	128,71	102,97	85,81	73,55	45,80	
HP	0,00	4,00	10,00	20,00	30,00	40,00	40,00	40,00	40,00	40,00	
	Locked Rotor	Pull-Up	Breakdown	Rated Load	Idle	Duty	S. F.	Ambient	Elevation	dBA @ 1M	
Speed (RPM)	0	1620	2700	3550	3600	S1	1,15	40°C	3,300 ft	-	
Current (Amps)	345,33	276,27	193,39	45,80	36,99	VFD Rating: Meets MG1 parts 31.4.4.2					
Torque (ft-lbs)	121,91	103,62	139,07	59,18	0,0	CT :	10:1	VT :	20:1		

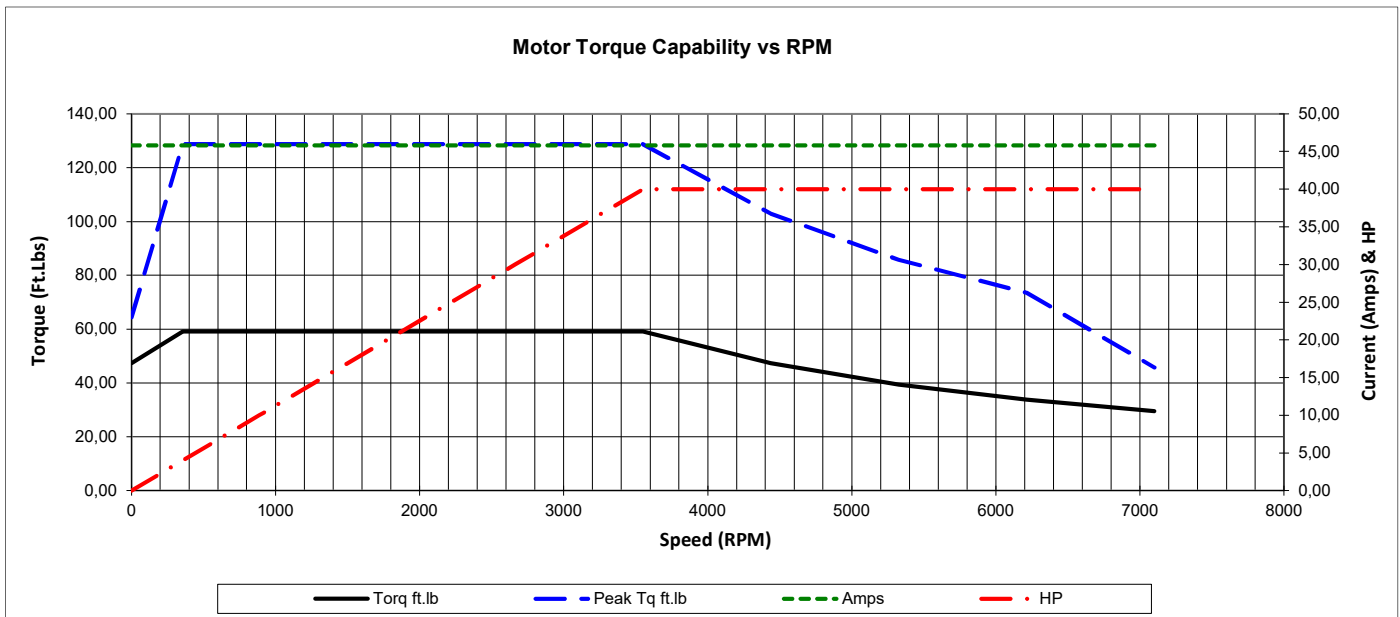
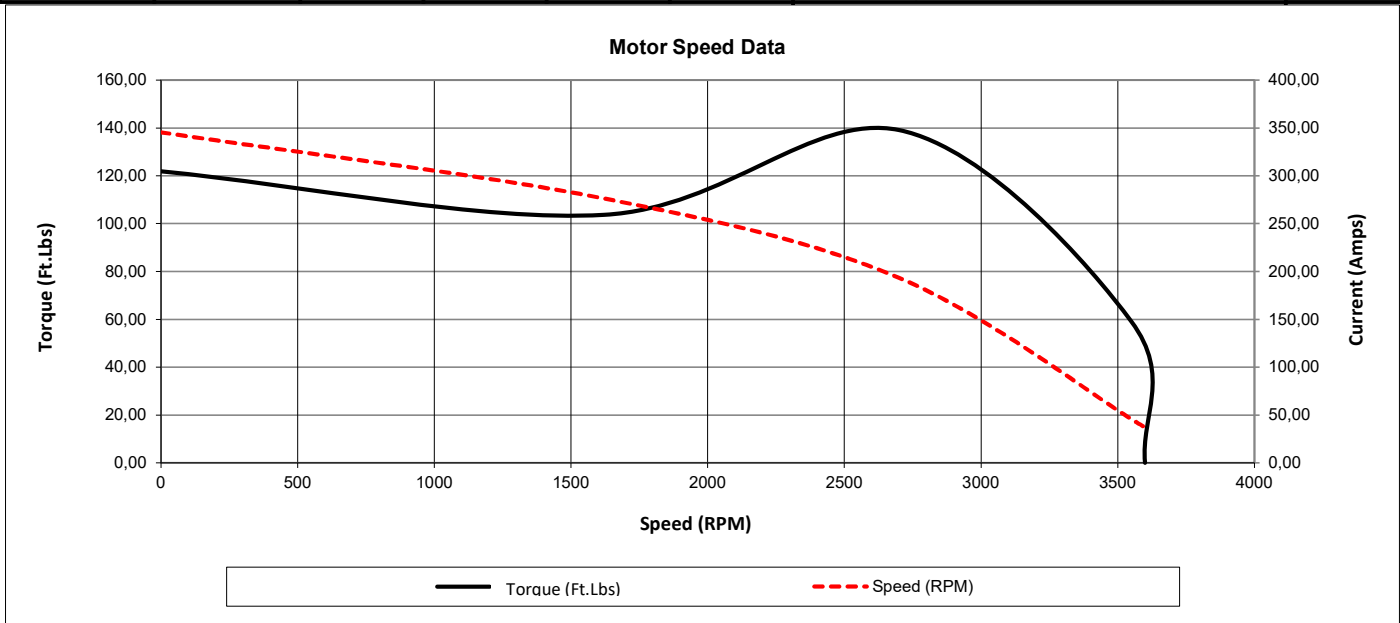

Date: **25 janvier, 2024**
 Customer: _____
 Contact: _____
 Submittee: **J.C. Lavallée**

Catalogue #: **IJC200L1-2-47**

IEC Efficiency Level IE3											
HP	Kw	VAC	RPM	Enclosure	Frame	Frequency	Design	Poles	LR Is/In	Insulation Class	Temp. Rise °C
40,00	29,84	460 / 796	3550	TEFC	200L	60	N	2	7,54	H	58,3

Load %	0%	25%	50%	75%	100%	125%	150%
Amps	36,99	36,99	40,52	42,28	45,80	52,85	66,94
Torq ft/lbs	0	14,64	29,38	44,23	59,18	77,13	99,07
RPM	0	3588	3575	3563	3550	3404	3181
Eff %	0	68,0	90,9	92,3	92,4	90,0	82,7
PF %	0	40,7	80,5	86,6	89,0	91,7	93,5

	Locked Rotor	Pull-Up	Breakdown	Rated Load	Idle	Duty	S. F.	Ambient	Elevation	dBA @ 1M
Speed (RPM)	0	1620	2700	3550	3600	S1	1,15	40°C	3,300 ft	-
Current (Amps)	345,33	276,27	193,39	45,80	36,99	VFD Rating: Meets MG1 parts 31.4.4.2				
Torque (ft-lbs)	121,91	103,62	139,07	59,18	0,0	CT :	10:1	VT :	20:1	

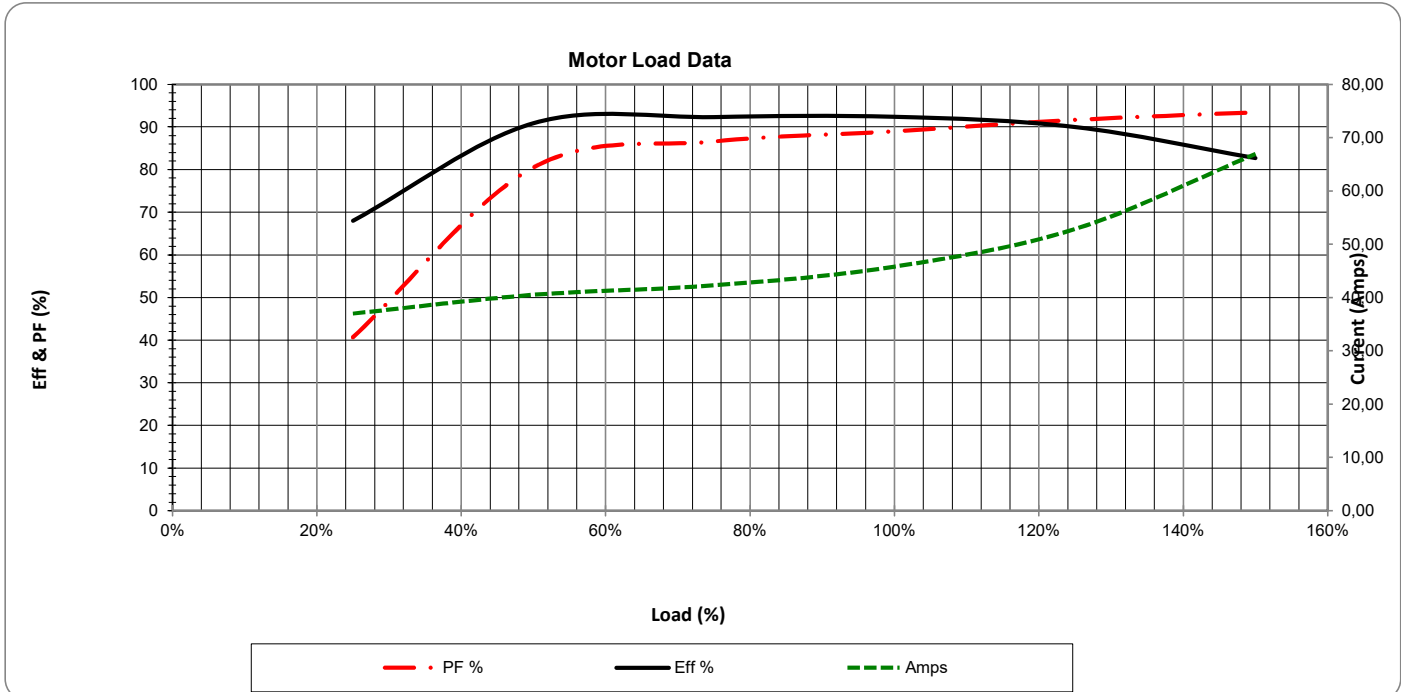
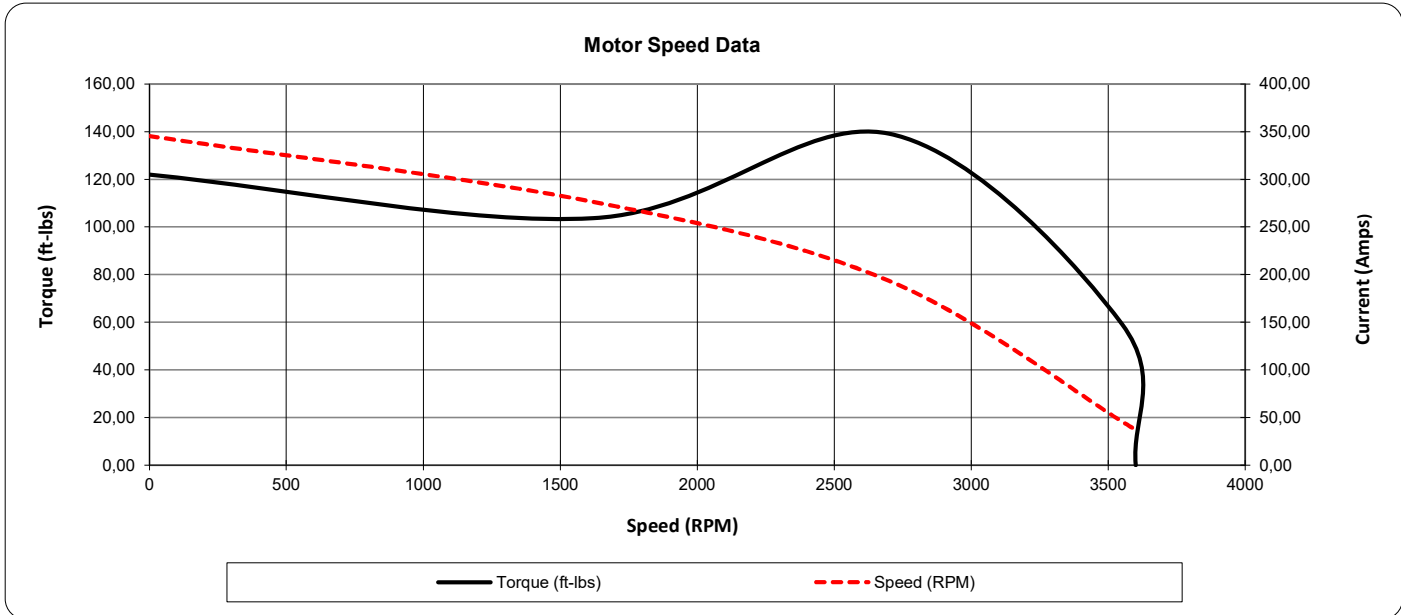

MaxMotion

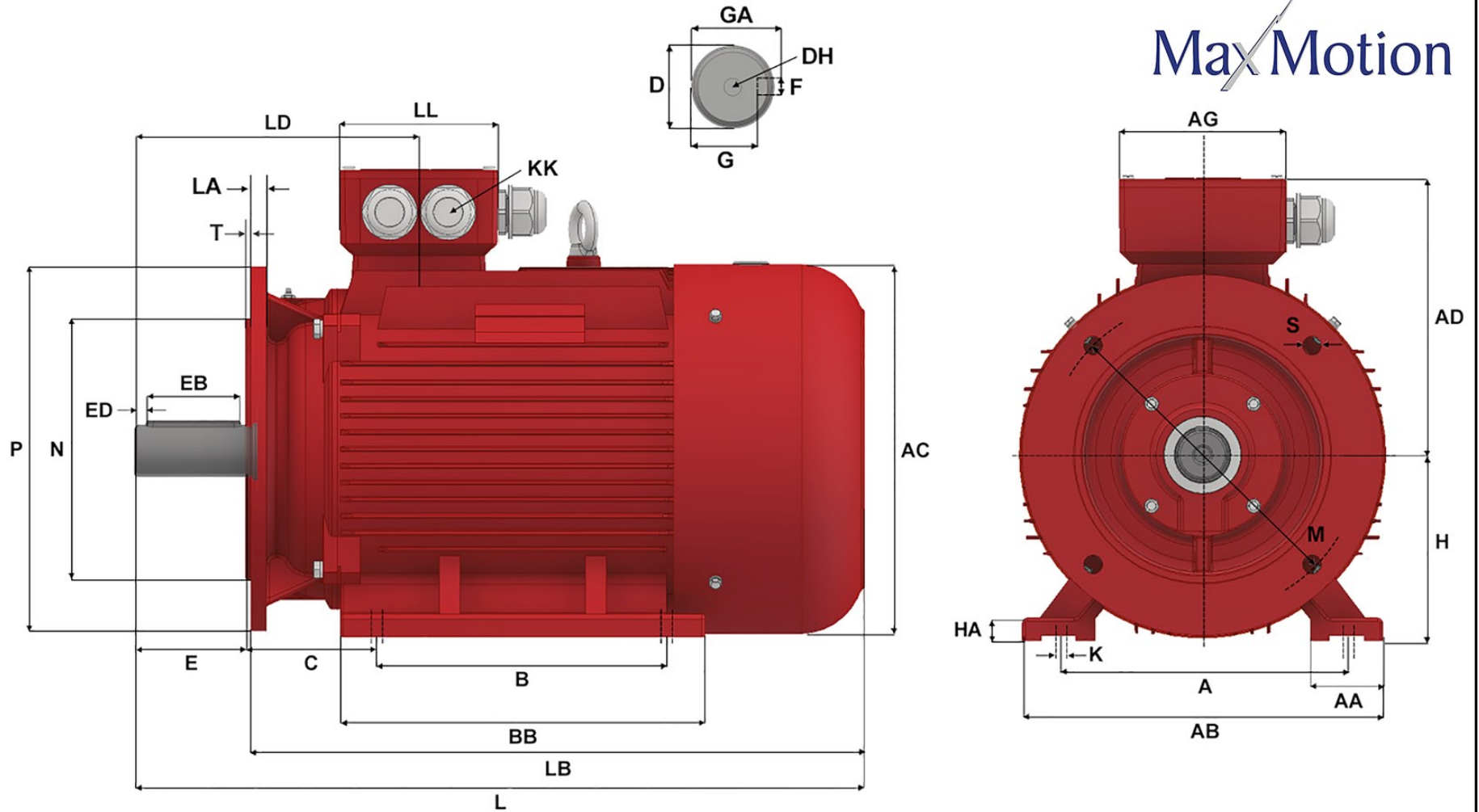

Version: 1JLEM		Revised: 09-11-2019				HP	RPM	FRAME	ENCLOSURE	IJC200L1-2-B35							
Customer is responsible in determining that Max Motion product will fit/perform suitably in the intended application										40	3560	200L	TEFC				
A	B	C	D	E	F	G	H	K	L	M	N	P					
318	305	133	55	110	16	49	200	4 - ϕ 18.5	746	350	300	400					
S	T	AA	AB	AC	AD	AG	BA	BB	DH	EB	ED	GA					
18.5	5	70	388	400	304	210	0	369	M20 X 42	100	5	59					
HA	KK (1)	KK (2)	KK (3)	LA	LB	LD	LL										
25	M50 X 1.5	1.5" NPT	M16 X 1.5	17	636	296	190										

METRIC IE1 & IE3 ALUMINUM & CAST IRON MOTORS

IEC DESIGN, WITH NEMA B TORQUE CURVES

TEFC TOTALLY ENCLOSED FAN COOLED

MaxMotion

Applications:

General purpose use on conveyors, compressors, pumps, fans, blowers and other industrial and process machinery. Motors can be locally modified to match special electrical designs such as 2 speed or any non-standard connection requirements. Special mechanical requirements such as shafts or flanges can be fabricated in 3-4 days.



Features:

Design - IEC Standard 60034-1 for energy efficiency, rotating electrical machines part 2-1, compliant with efficiency standards covered by NEMA, CSA, CEMEP, COPANT, AS, NZS, JIS and GB.

Agency Listings and Standard - IEC, IEEE, CSA, CSAus, CE, NEMA, DOE, NRCan

Service Factor - 1.15 @ 60Hz and 1.0 @ 50Hz without derating power

Electrical Supply - At 60Hz, standard voltages are: 230 / 460 VAC: Fractional to 30HP, 460 / 796 VAC: 30HP to 300HP, 333 / 575 VAC: Fractional to 5.5HP, 575 / 990 VAC: 5.5HP to 300HP

At 50Hz, standard voltages are: 190 -220 / 380 - 415 VAC: Fractional to 30HP,

380 - 415 / 660 - 725 VAC: 30HP to 300HP

*Custom voltages available on request i.e. 690V

Windings - Highest quality Enamel coated magnet wire. VPI with 2 stage dip and bake.

Insulation - Non hygroscopic Class H with Class B temperature rise

Voltage and Frequency Variation - $\pm 10\%$ on 2 rated voltage points, $\pm 5\%$ on frequency per regulation en 60204-1

Bearings - SKF single row deep groove ball bearings, frame sizes 132+ have re-greasing capabilities.

*Special bearings are available on request.

Earthing Terminals - 1 in the terminal box and 1 on body of the motor.

Bearing Lubricant - For regreasable bearings, our standard is Polyrex EM (- 29°C to 177°C temperature range)

Enclosure Protection - Standard is IP55, others such as IP56, IP65 available on request

Frame Construction - Frames 56-160 are pressured die cast aluminum with base that can be removed/applied to accommodate F0, F1, F2 terminal box positions. Frames 180-355 are cast iron construction with F0 terminal box position.

Conduit Box - Large square cast aluminum terminal box designed to meet NEC space requirements. Can be rotated in 90 degree increments. Equipped with both NPT and PG plugs. Wiring diagram is embossed on the back of the cover. Inside you will find clearly marked stud type terminal blocks and leads identified in IEC format. Frames 132+ come equipped with extra gland for PTC connection.

Inverter Duty - Suitable for Inverter Duty applications, at all voltages for speed ranges of 10:1 constant torque and 20:1 variable torque. Meets NEMA MG-1 Part 31.4.4.2 criteria.

Nameplate - Oversized painted aluminum nameplate with 60Hz and 50Hz performance specifications along with multiple approval ratings.

Drain Hole - Cast iron frames, located in center bottom of casting.

Fan Cover - Rolled steel on all frame sizes, cast iron available on request

Warranty - 3 years from the date of manufacture



HP	KW	FL RPM	VOLTS	FRAME	CAT NO.	CONSTRUCTION	NOM EFF.	F.L. AMPS	WT (lbs)	DE BRG	ODE BRG	"L" Dimension (Inch)
0.13	0.09	1590	230/460	56	IJA562-4-24	Aluminum	54	.69/.34	7.7	6201ZZ-C3	6201ZZ-C3	198.5
		1590	333/575	56	IJA562-4-35	Aluminum	54	.47/.27	7.7	6201ZZ-C3	6201ZZ-C3	198.5
		1020	333/575	63	IJA631-6-35	Aluminum	44	.61/.35	9.9	6201ZZ-C3	6201ZZ-C3	217
0.17	0.12	3240	230/460	56	IJA562-2-24	Aluminum	64	.65/.33	7.7	6201ZZ-C3	6201ZZ-C3	198.5
		3240	333/575	56	IJA562-2-35	Aluminum	64	.45/.26	7.7	6201ZZ-C3	6201ZZ-C3	198.5
		1630	230/460	63	IJA631-4-24	Aluminum	62	.76/.38	8.6	6201ZZ-C3	6201ZZ-C3	217
		1630	333/575	63	IJA631-4-35	Aluminum	62	.53/.31	8.6	6201ZZ-C3	6201ZZ-C3	217
0.25	0.19	1020	333/575	63	IJA632-6-35	Aluminum	48	.72/.42	11	6201ZZ-C3	6201ZZ-C3	217
		3320	230/460	63	IJA631-2-24	Aluminum	63	.92/.46	9.46	6201ZZ-C3	6201ZZ-C3	217
		3320	333/575	63	IJA631-2-35	Aluminum	63	.61/.35	9.46	6201ZZ-C3	6201ZZ-C3	217
		1570	230/460	63	IJA632-4-24	Aluminum	66	.94/.47	8.8	6201ZZ-C3	6201ZZ-C3	217
		1570	333/575	63	IJA632-4-35	Aluminum	66	.65/.38	8.8	6201ZZ-C3	6201ZZ-C3	217
		1020	230/460	71	IJA711-6-24	Aluminum	52.5	1.3/.65	15.4	6202ZZ-C3	6202ZZ-C3	245
0.33	0.25	1020	333/575	71	IJA711-6-35	Aluminum	52.5	.90/.52	15.4	6202ZZ-C3	6202ZZ-C3	245
		3260	230/460	63	IJA632-2-24	Aluminum	64	1.21/.61	8.8	6201ZZ-C3	6201ZZ-C3	217
		3260	333/575	63	IJA632-2-35	Aluminum	64	.84/.48	8.8	6201ZZ-C3	6201ZZ-C3	217
		1595	230/460	63	IJA633-4-24	Aluminum	68	1.25/.62	11	6201ZZ-C3	6201ZZ-C3	217
		1595	333/575	63	IJA633-4-35	Aluminum	68	.86/.50	11	6201ZZ-C3	6201ZZ-C3	217
		1595	230/460	71	IJA711-4-24	Aluminum	68	1.25/.62	11	6201ZZ-C3	6201ZZ-C3	245
		1595	333/575	71	IJA711-4-35	Aluminum	68	.86/.50	11	6201ZZ-C3	6201ZZ-C3	245
		1020	230/460	71	IJA712-6-24	Aluminum	57.5	1.6/.80	15.4	6202ZZ-C3	6202ZZ-C3	245
		1020	333/575	71	IJA712-6-35	Aluminum	57.5	1.11/.64	15.4	6202ZZ-C3	6202ZZ-C3	245
0.5	0.37	3285	230/460	63	IJA633-2-24	Aluminum	70	1.64/.82	11	6201ZZ-C3	6201ZZ-C3	217
		3285	333/575	63	IJA633-2-35	Aluminum	70	1.13/.66	11	6201ZZ-C3	6201ZZ-C3	217
		3285	230/460	71	IJA711-2-24	Aluminum	70	1.64/.82	11	6202ZZ-C3	6202ZZ-C3	245
		3285	333/575	71	IJA711-2-35	Aluminum	70	1.13/.66	11	6202ZZ-C3	6202ZZ-C3	245
		1595	230/460	71	IJA712-4-24	Aluminum	70	1.77/.88	12.1	6202ZZ-C3	6202ZZ-C3	245
		1595	333/575	71	IJA712-4-35	Aluminum	70	1.22/.71	12.1	6202ZZ-C3	6202ZZ-C3	245
		1060	230/460	80	IJA801-6-24	Aluminum	62	2.14/1.04	20.24	6204ZZ-C3	6204ZZ-C3	286
		1060	333/575	80	IJA801-6-35	Aluminum	62	1.48/.86	20.24	6204ZZ-C3	6204ZZ-C3	286
0.75	0.56	3285	230/460	71	IJA712-2-24	Aluminum	72	2.34/1.17	13.2	6202ZZ-C3	6202ZZ-C3	245
		3285	333/575	71	IJA712-2-35	Aluminum	72	1.62/.94	13.2	6202ZZ-C3	6202ZZ-C3	245
		1665	230/460	71	IJA713-4-24	Aluminum	74	2.49/1.24	16.5	6202ZZ-C3	6202ZZ-C3	245
		1665	333/575	71	IJA713-4-35	Aluminum	74	1.72/1	16.4	6202ZZ-C3	6202ZZ-C3	245
		1680	230/460	80	IJA2801-4-24	Aluminum	81.1	2.27/1.13	20	6204ZZ-C3	6204ZZ-C3	285
		1680	333/575	80	IJA2801-4-35	Aluminum	81.1	1.56/0.90	20	6204ZZ-C3	6204ZZ-C3	285
		1060	230/460	80	IJA2802-6-24	Aluminum	72	2.91/1.45	22	6204ZZ-C3	6204ZZ-C3	285
		1060	333/575	80	IJA2802-6-35	Aluminum	72	2.01/1.16	22	6204ZZ-C3	6204ZZ-C3	285
1	0.75	3455	230/460	71	IJA713-2-24	Aluminum	77	2.98/1.49	16.5	6202ZZ-C3	6202ZZ-C3	245
		3455	333/575	71	IJA713-2-35	Aluminum	77	2.06/1.19	16.5	6202ZZ-C3	6202ZZ-C3	245
		3455	230/460	80	IJA2801-2-24	Aluminum	77	2.98/1.49	19.8	6204ZZ-C3	6204ZZ-C3	285
		3455	333/575	80	IJA2801-2-35	Aluminum	77	2.06/1.19	19.8	6204ZZ-C3	6204ZZ-C3	285
		1704	230/460	80	IJA2802-4-24	Aluminum	83.5	3.01/1.50	24.4	6204ZZ-C3	6204ZZ-C3	285
		1704	333/575	80	IJA2802-4-35	Aluminum	83.5	2.07/1.20	24.4	6204ZZ-C3	6204ZZ-C3	285
		1120	230/460	90	IJA2905-6-24	Aluminum	82.5	3.21/1.61	35.2	6205ZZ-C3	6205ZZ-C3	315
		1120	333/575	90	IJA2905-6-35	Aluminum	82.5	2.22/1.29	35.2	6205ZZ-C3	6205ZZ-C3	315
1.5	1.12	3455	230/460	80	IJA2802-2-24	Aluminum	84	3.96/1.98	19.3	6204ZZ-C3	6204ZZ-C3	285
		3455	333/575	80	IJA2802-2-35	Aluminum	84	2.74/1.58	19.3	6204ZZ-C3	6204ZZ-C3	285
		1665	230/460	80	IJA803-4-24-IE3	Aluminum	79	4.54/2.27	23.1	6204ZZ-C3	6204ZZ-C3	300
		1665	333/575	80	IJA803-4-35-IE3	Aluminum	79	3.14/1.82	23.1	6204ZZ-C3	6204ZZ-C3	300
		1734	230/460	90	IJA2905-4-24	Aluminum	86.5	4.2/2.1	35.2	6205ZZ-C3	6205ZZ-C3	315
		1734	333/575	90	IJA2905-4-35	Aluminum	86.5	2.90/1.68	35.2	6205ZZ-C3	6205ZZ-C3	315
		1134	230/460	90	IJA290L-6-24	Aluminum	87.5	4.32/2.16	49.2	6205ZZ-C3	6205ZZ-C3	340
2	1.5	1134	333/575	90	IJA290L-6-35	Aluminum	87.5	2.99/1.73	49.2	6205ZZ-C3	6205ZZ-C3	340
		3470	230/460	80	IJA803-2-24-IE3	Aluminum	85.5	5.24/2.62	26.4	6204ZZ-C3	6204ZZ-C3	300
		3470	333/575	80	IJA803-2-35-IE3	Aluminum	85.5	3.62/2.10	26.4	6204ZZ-C3	6204ZZ-C3	300
		3474	230/460	90	IJA2905-2-24	Aluminum	85.5	5.24/2.62	29.7	6205ZZ-C3	6205ZZ-C3	315
		3474	333/575	90	IJA2905-2-35	Aluminum	85.5	3.62/2.10	29.7	6205ZZ-C3	6205ZZ-C3	315
		1734	230/460	90	IJA290L-4-24	Aluminum	86.5	5.65/2.83	39.6	6205ZZ-C3	6205ZZ-C3	340
		1734	333/575	90	IJA290L-4-35	Aluminum	86.5	3.90/2.26	39.6	6205ZZ-C3	6205ZZ-C3	340
		1139	230/460	100	IJA2100L-6-24	Aluminum	88.5	5.80/2.90	73.7	6206ZZ-C3	6206ZZ-C3	380
2.4	1.79	1139	333/575	100	IJA2100L-6-35	Aluminum	88.5	4.01/2.32	73.7	6206ZZ-C3	6206ZZ-C3	380
		1730	230/460	90	IJA90L2-4-24	Aluminum	86.5	6.70/3.35	45.1	6205ZZ-C3	6205ZZ-C3	345
3	2.24	1730	333/575	90	IJA90L2-4-35	Aluminum	86.5	4.63/2.68	45.1	6205ZZ-C3	6205ZZ-C3	345
		3474	230/460	90	IJA290L-2-24	Aluminum	86.5	7.51/3.76	37.4	6205ZZ-C3	6205ZZ-C3	340
		3474	333/575	90	IJA290L-2-35	Aluminum	86.5	5.19/3.01	37.4	6205ZZ-C3	6205ZZ-C3	340
		1740	230/460	100	IJA2100L1-4-24	Aluminum	89.5	7.60/3.80	55	6206ZZ-C3	6206ZZ-C3	380
		1740	333/575	100	IJA2100L1-4-35	Aluminum	89.5	5.25/3.04	55	6206ZZ-C3	6206ZZ-C3	380
		1145	230/460	112	IJA2112M-6-46	Aluminum	89.5	8.30/4.20	66	6306ZZ-C3	6306ZZ-C3	401
		1145	575/990	112	IJA2112M-6-59	Aluminum	89.5	5.80/3.36	66	6306ZZ-C3	6306ZZ-C3	401

HP	KW	FL RPM	VOLTS	FRAME	CAT NO.	CONSTRUCTION	NOM EFF.	F.L. AMPS	WT (Lbs)	DE BRG	ODE BRG	"L" Dimension (Inch)		
4	2.98	3470	230/460	90	IJA90L2-2-24	Aluminum	88.5	9.78/4.89	42.9	6206ZZ-C3	6206ZZ-C3	345		
		3470	333/575	90	IJA90L2-2-35	Aluminum	88.5	6.76/3.91	42.9	6206ZZ-C3	6206ZZ-C3	345		
		3474	230/460	100	IJA2100L-2-24	Aluminum	88.5	9.80/4.90	50.6	6206ZZ-C3	6206ZZ-C3	380		
		3474	333/575	100	IJA2100L-2-35	Aluminum	88.5	6.77/3.92	50.6	6206ZZ-C3	6206ZZ-C3	380		
		1740	230/460	100	IJA2100L2-4-24	Aluminum	89.5	10.30/5.10	67.1	6206ZZ-C3	6206ZZ-C3	380		
		1740	333/575	100	IJA2100L2-4-35	Aluminum	89.5	7.05/4.08	67.1	6206ZZ-C3	6206ZZ-C3	380		
		1160	230/460	132	IJA132S-6-46	Aluminum	89.5	11.40/5.69	91.3	6308ZZ-C3	6308ZZ-C3	445		
		1160	575/990	132	IJA132S-6-59	Aluminum	89.5	4.55/2.64	91.3	6308ZZ-C3	6308ZZ-C3	445		
5.5	4.1	3485	230/460	100	IJA100L2-2-24	Aluminum	88.5	12.90/6.45	63.8	6306ZZ-C3	6306ZZ-C3	405		
		3485	575/990	100	IJA100L2-2-35	Aluminum	88.5	8.90/5.16	63.8	6306ZZ-C3	6306ZZ-C3	405		
		3485	230/460	112	IJA2112M-2-46	Aluminum	88.5	12.90/6.40	63.9	6306ZZ-C3	6306ZZ-C3	401		
		3485	575/990	112	IJA2112M-2-59	Aluminum	88.5	8.84/5.12	63.9	6306ZZ-C3	6306ZZ-C3	401		
		1725	230/460	112	IJA2112M-4-46	Aluminum	89.5	13.70/6.80	82.5	6306ZZ-C3	6306ZZ-C3	401		
		1725	575/990	112	IJA2112M-4-59	Aluminum	89.5	9.39/5.44	82.5	6306ZZ-C3	6306ZZ-C3	401		
		1160	230/460	132	IJA132M1-6-46	Aluminum	89.5	15.20/7.58	108.9	6308ZZ-C3	6308ZZ-C3	485		
		1160	575/990	132	IJA132M1-6-59	Aluminum	89.5	6.10/3.52	108.9	6308ZZ-C3	6308ZZ-C3	485		
7.5	5.6	3515	230/460	112	IJA2112M2-2-46	Aluminum	89.5	17.50/8.76	79.2	6306ZZ-C3	6306ZZ-C3	401		
		3515	575/990	112	IJA2112M2-2-59	Aluminum	89.5	12.10/7.01	79.2	6306ZZ-C3	6306ZZ-C3	401		
		3515	230/460	132	IJA132S1-2-46	Aluminum	89.5	17.50/8.76	94.6	6308ZZ-C3	6308ZZ-C3	445		
		3515	575/990	132	IJA132S1-2-59	Aluminum	89.5	7.01/4.07	94.6	6308ZZ-C3	6308ZZ-C3	445		
		1750	230/460	132	IJA132S-4-46	Aluminum	91.7	18.10/9.07	107.8	6308ZZ-C3	6308ZZ-C3	445		
		1750	575/990	132	IJA132S-4-59	Aluminum	91.7	7.26/4.21	107.8	6308ZZ-C3	6308ZZ-C3	445		
		1160	230/460	132	IJA132M2-6-46	Aluminum	91	20.20/10.10	133	6308ZZ-C3	6308ZZ-C3	485		
		1160	575/990	132	IJA132M2-6-59	Aluminum	91	8.09/4.70	133	6308ZZ-C3	6308ZZ-C3	485		
10	7.46	3515	230/460	112	IJA112M3-2-46	Aluminum	90.2	23.7/11.9	84.7	6308ZZ-C3	6308ZZ-C3	400		
		3515	575/990	112	IJA112M3-2-59	Aluminum	90.2	9.49/5.51	84.7	6308ZZ-C3	6308ZZ-C3	400		
		3515	230/460	132	IJA132S2-2-46	Aluminum	90.2	23.70/11.90	105.6	6308ZZ-C3	6308ZZ-C3	445		
		3515	575/990	132	IJA132S2-2-59	Aluminum	90.2	9.49/5.51	105.6	6308ZZ-C3	6308ZZ-C3	445		
		1750	230/460	132	IJA132M-4-46	Aluminum	91.7	24.40/12.20	128.7	6308ZZ-C3	6308ZZ-C3	485		
		1750	575/990	132	IJA132M-4-59	Aluminum	91.7	9.78/5.68	128.7	6308ZZ-C3	6308ZZ-C3	485		
		1160	230/460	160	IJA160M-6-46	Aluminum	91	26.20/13.10	184.8	6309-C3	6309-C3	615		
		1160	575/990	160	IJA160M-6-59	Aluminum	91	10.50/6.08	184.8	6309-C3	6309-C3	615		
12.4	9.25	3530	230/460	132	IJA132M1-2-46	Aluminum	90.2	28.90/14.50	125.4	6308ZZ-C3	6308ZZ-C3	485		
		3530	575/990	132	IJA132M1-2-59	Aluminum	90.2	11.60/6.72	125.4	6308ZZ-C3	6308ZZ-C3	485		
		1750	230/460	132	IJA132M1-4-46	Aluminum	90.4	30.60/15.30	158.4	6308ZZ-C3	6308ZZ-C3	485		
		1750	575/990	132	IJA132M1-4-59	Aluminum	90.4	12.20/7.10	158.4	6308ZZ-C3	6308ZZ-C3	485		
15	11.19	3530	230/460	132	IJA132M2-2-46	Aluminum	91	34.10/17	129.8	6308ZZ-C3	6308ZZ-C3	485		
		3530	575/990	132	IJA132M2-2-59	Aluminum	91	13.60/7.92	129.8	6308ZZ-C3	6308ZZ-C3	485		
		3530	230/460	160	IJA160M1-2-46	Aluminum	91	34.10/17	185.9	6309-C3	6309-C3	615		
		3530	575/990	160	IJA160M1-2-59	Aluminum	91	13.60/7.92	185.9	6309-C3	6309-C3	615		
		1755	230/460	160	IJA160M-4-46	Aluminum	92.4	35.20/17.60	221.1	6309-C3	6309-C3	615		
		1755	575/990	160	IJA160M-4-59	Aluminum	92.4	14.10/8.17	221.1	6309-C3	6309-C3	615		
		1160	230/460	160	IJA160L-6-46	Aluminum	91.7	37.60/18.80	236.5	6309-C3	6309-C3	660		
		1160	575/990	160	IJA160L-6-59	Aluminum	91.7	15.04/8.71	236.5	6309-C3	6309-C3	660		
20	14.92	3530	230/460	132	IJA132M3-2-46	Aluminum	91	46.5/23.2	143	6308-C3	6308-C3	485		
		3530	575/990	132	IJA132M3-2-59	Aluminum	91	18.6/10.8	143	6309-C3	6309-C3	485		
		3530	230/460	160	IJA160M2-2-46	Aluminum	91	46.50/23.20	210.1	6309-C3	6309-C3	615		
		3530	575/990	160	IJA160M2-2-59	Aluminum	91	18.60/10.80	210.1	6309-C3	6309-C3	615		
		1755	230/460	160	IJA160L-4-46	Aluminum	93	47.10/23.50	237.6	6309-C3	6309-C3	660		
		1755	575/990	160	IJA160L-4-59	Aluminum	93	18.80/10.90	237.6	6309-C3	6309-C3	660		
		1170	230/460	180	IJC180L-6-46	Cast Iron	91.7	50.70/25.30	430	6311-C3	6311-C3	690		
		1170	575/990	180	IJC180L-6-59	Cast Iron	91.7	20.24/11.73	430	6311-C3	6311-C3	690		
25	18.65	3525	230/460	160	IJA160L-2-46	Cast Iron	91.7	56.90/28.50	238.7	6309-C3	6309-C3	660		
		3525	575/990	160	IJA160L-2-59	Cast Iron	91.7	22.80/13.20	238.7	6309-C3	6309-C3	660		
		1760	230/460	180	IJC180M-4-46	Cast Iron	93.6	57.70/28.80	406	6311-C3	6311-C3	652		
		1760	575/990	180	IJC180M-4-59	Cast Iron	93.6	23.10/13.40	406	6311-C3	6311-C3	652		
		1175	460/796	200	IJC200L1-6-47	Cast Iron	93	30.80/17.80	507.8	6312-C3	6312-C3	746		
		1175	575/990	200	IJC200L1-6-59	Cast Iron	93	24.64/14.30	507.8	6312-C3	6312-C3	746		
		30	22.38	3545	230/460	160	IJA160L2-2-46	Cast Iron	91.7	67.70/33.80	245.3	6309-C3	6309-C3	660
				3545	575/990	160	IJA160L2-2-59	Cast Iron	91.7	27.10/15.70	245.3	6309-C3	6309-C3	660
3545	230/460			180	IJC180M-2-46	Cast Iron	91.7	67.70/33.80	412.7	6311-C3	6311-C3	652		
3545	575/990			180	IJC180M-2-59	Cast Iron	91.7	27.10/15.70	412.7	6311-C3	6311-C3	652		
1760	230/460			180	IJC180L-4-46	Cast Iron	93.6	68.60/34.30	467	6311-C3	6311-C3	690		
1760	575/990			180	IJC180L-4-59	Cast Iron	93.6	27.40/15.90	467	6311-C3	6311-C3	690		
1175	460/796			200	IJC200L2-6-47	Cast Iron	93	36.70/21.20	358.8	6312-C3	6312-C3	746		
1175	575/990			200	IJC200L2-6-59	Cast Iron	93	29.36/26.10	358.8	6312-C3	6312-C3	746		
40	29.84	3550	460/796	200	IJC200L1-2-47	Cast Iron	92.4	45.80/26.50	550	6312-C3	6312-C3	746		
		3550	575/990	200	IJC200L1-2-59	Cast Iron	92.4	36.60/21.30	550	6312-C3	6312-C3	746		
		1770	460/796	200	IJC200L-4-47	Cast Iron	94.1	46.50/26.90	583	6312-C3	6312-C3	746		
		1770	575/990	200	IJC200L-4-59	Cast Iron	94.1	37.20/21.60	583	6312-C3	6312-C3	746		
		1175	460/796	225	IJC225M-6-47	Cast Iron	94.1	48.20/27.90	667	6313-C3	6313-C3	810		
		1175	575/990	225	IJC225M-6-59	Cast Iron	94.1	38.56/22.40	667	6313-C3	6313-C3	810		



Our oversized aluminium nameplate allows for quick reference to both 60 and 50Hz performance values spread across a wide voltage range. Multiple approval ratings provides locally compliant motors ready for export to over 28 global regions. The Max Motion IEC line is designed to meet or exceed all IEC 34 and 72 electrical standards while satisfying NEMA MG1 Part 31.4.4.2 for VFD inverter fed applications.



Heat has long been the great adversary for motor longevity. We address this concern logically by the use of a class H insulation system throughout the motor windings and leads. All of our motors exceed the criteria critical for optimal operation in 10:1 Constant Torque and 20:1 Variable Torque applications. This hybrid platform meets both IEC Design N and NEMA Design B Torque characteristics.



A large, square, cast aluminium T-box has been designed to meet NEC space requirements. Equipped with NPT and PG plugs, it can be rotated in 90 degree increments and boasts a wiring diagram embossed on to the back of the cover. There are no plastic cost outs here! Inside are clearly marked, stud type terminal blocks and leads marked in the proper IEC format.



Knowing that over 57% of motor failures occur due to bearings, it's understood that bearings play an essential role in a motor's life cycle. This is why we use over-sized SKF Explorer Deep Groove Ball Bearings in our motors, as standard. We went the extra mile to include re-greasing capabilities from frame sizes 132 to 355. In conjunction with the Class H insulation system, you get a cool running motor which gives us the ability to offer our customers a full 3 year warranty.



Frame sizes 56 – 160 are of lightweight aluminium construction, with removable base and flexible multi-orientation capability (F1, F2, F3). With an ultra-smooth and elongated fin design, heat is dissipated quickly. Cast iron frames are available from sizes 180 – 500 and offers the same fin design as with aluminium units. Rolled steel fan covers are standard on all frames and special cast iron fan covers can be furnished upon request.



MaxMotion

MEP INC

Ontario, Western
Canada, Newfound-
land, Labrador and USA

2831 Bristol Circle Unit 3
Oakville, ON L6H 6X5
Tel: 905-829-1020
Toll free: 877-812-7788
Email: information@mep.ca

Quebec and Maritimes

10500 Boul. du Golf
Anjou, QC H1J 2Y7
Tel: 514-352-1229
Toll free: 888-668-3877
Email: info@mep.ca

